



BluE-G series

3000S/3000D/3600D/4000D/4200D/4600D/5000D/6000D

Grid-Connected Inverter Installation and Operation Manual

Contents

1. Introduction	3
1.1 Product Description	3
1.2 Packaging	4
1.3 Optional Packaging	4
2. Safety Instructions	5
2.1 Safety Symbols	5
2.2 General Safety Instructions	5
2.3 Notice For Use.....	6
3. Overview	7
3.1 Front Panel Display	7
3.2 LED Status Indicator Lights	7
3.3 Keypad	8
3.4 LCD	8
4. Installation	9
4.1 Select Location for the Inverter	9
4.2 Mounting the Inverter.....	11
4.3 Electrical Connections	13
4.3.1 Connect PV side of inverter	13
4.3.2 Connect grid side of inverter	16
4.3.3 External ground connection	18
4.3.4 Max. overcurrent protection device (OCPD).....	19
4.3.5 Inverter monitoring connection	20
4.3.6 CT connections (optional)	21
4.3.7 DRED port connections(optional).....	22
5. Start & Stop	23
5.1 Start the Inverter	23
5.2 Stop the Inverter	23

Contents

- 6. Operation24
 - Lock screen24
 - Main Menu25
 - 6.1 Setup-Technicians Only25
 - 6.1.1 Set Date/Time26
 - 6.2 Inquire26
 - 6.3 Statistics26
- 7. Maintenance27
- 8. Trouble shooting27
- 9. Specifications31
- 10. Quality Assurance35
- 11. Contact Information36

01 Introduction

1.1 Product Description

BluE-G series single phase inverters integrate DRM and backflow power control function, that could suitable for smart grid requirement. BluE-G series inverter contain 8 models which are listed below: 3000S/3000D/3600D/4000D/4200D/4600D/5000D/6000D.

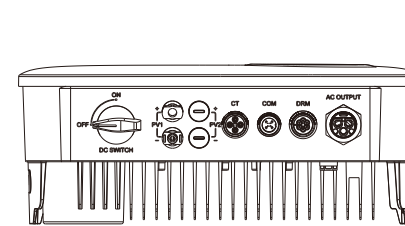
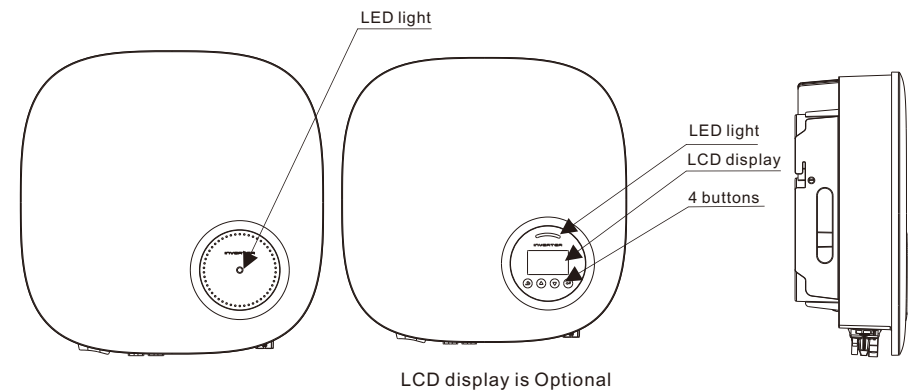

▲ Figure 1.2a Bottom side view (BluE-G 3000S)

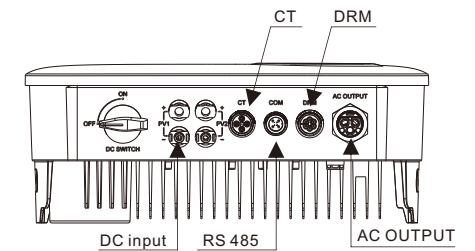

▲ Figure 1.2b Bottom side view (others)

Object	Description	DVC class	Object	Description	DVC class
1	PV1, PV2	DVC C	2	AC OUTPUT	DVC C
3	DRM	DVC A	4	CT	DVC A
5	COM	DVC A			

1.2 Packaging

When you receive the inverter, ensure that all the parts listed below are included:

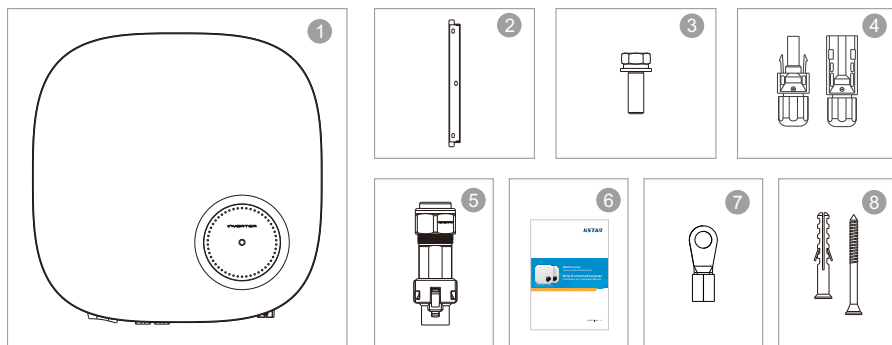

Part #	Description	Number
1	PV grid tie inverter	1
2	Wall/pole bracket	1
3	Locking screws	2
4	DC connector	1 pair for BluE-G 3000S, 2 pairs for others
5	AC connector	1
6	Manual	1
7	OT terminal	1
8	Explosion-proof screws	3

1.3 Optional Packaging

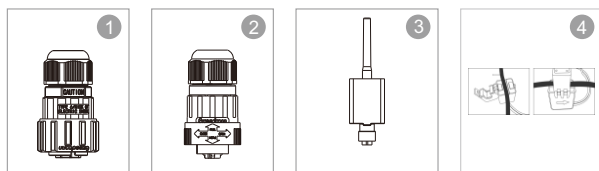

Part #	Description	Number
1	DRM connector	1
2	CT connector	1
3	WiFi/GPRS Stick	1
4	1xCT and com cable	1

02 Safety Instructions

Improper use may result in potential electric shock hazards or burns. This manual contains important instructions that should be followed during installation and maintenance. Please read these instructions carefully before use and keep them for future reference.

2.1 Safety Symbols

Safety symbols used in this manual, which highlight potential safety risks and important safety information, are listed as follows:

WARNING:
 WARNING symbol indicates important safety instructions, which if not correctly followed, could result in serious injury or death.

NOTE:
 NOTE symbol indicates important safety instructions, which if not correctly followed, could result in some damage or the destruction of the inverter.

CAUTION:
 CAUTION, RISK OF ELECTRIC SHOCK symbol indicates important safety instructions, which if not correctly followed, could result in electric shock.

CAUTION:
 CAUTION, HOT SURFACE symbol indicates safety instructions, which if not correctly followed, could result in burns.

2.2 General Safety Instructions

WARNING:
 Only devices in compliance with SELV (EN 69050) may be connected to the RS485 and USB interfaces.

WARNING:
 Please don't connect PV array positive(+) or negative(-) to ground, it could cause serious damage to the inverter.

WARNING:
 Electrical installations must be done in accordance with the local and national electrical safety standards.

WARNING:
 Do not touch any inner live parts until 5 minutes after disconnection from the utility grid and the PV input.

WARNING:



To reduce the risk of fire, over-current protective devices (OCPD) are required for circuits connected to the Inverter. The DC OCPD shall be installed per local requirements. All photovoltaic source and output circuit conductors shall have disconnects that comply with the NEC Article 690, Part II.

CAUTION:



Risk of electric shock. Do not remove cover. There is no user serviceable parts inside. Refer servicing to qualified and accredited service technicians.

CAUTION:



The PV array (Solar panels) supplies a DC voltage when they are exposed to sunlight.

CAUTION:



Risk of electric shock from energy stored in capacitors of the Inverter. Do not remove cover for 5 minutes after disconnecting all power sources(service technician only). Warranty may be voided if the cover is removed without unauthorized. If the equipment is used in a manner not specified by the manufacturer, the protection provided by the equipment may be impaired.

CAUTION:



The surface temperature of the inverter can reach up to 75°C (167 F). To avoid risk of burns, do not touch the surface of the inverter while it is operating. Inverter must be installed out of the reach of children.



PV module used with inverter must have an IEC 61730 Class A rating.

2.3 Notice For Use

The inverter has been constructed according to the applicable safety and technical guidelines. Use the inverter in installations that meet the following specifications ONLY:

1. Permanent installation is required.
2. The electrical installation must meet all the applicable regulations and standards.
3. The inverter must be installed according to the instructions stated in this manual.
4. The inverter must be installed according to the correct technical specifications.
5. To startup the inverter, the Grid Supply Main Switch (AC) must be switched on, before the solar panel's DC isolator shall be switched on. To stop the inverter, the Grid Supply Main Switch (AC) must be switched off before the solar panel's DC isolator shall be switched off.

03 Overview

3.1 Front Panel Display

LCD display is Optional.

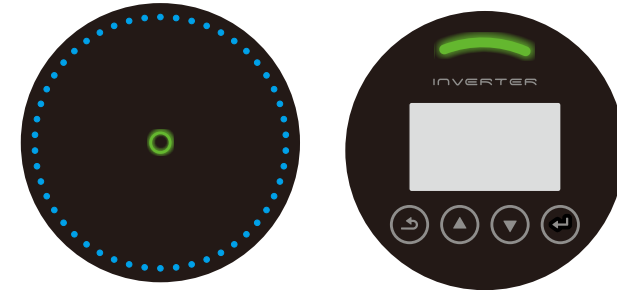

▲ Figure 3.1 Front Panel Display

3.2 LED Status Indicator Light

The LED status indicator can display red and green. When the indicator light is on, it indicates that there is power. When the indicator light is red, it indicates the alarm state; when the indicator light is green, it indicates the operation state.

Light	Status	Description
ALARM	ON	Alarm or fault condition is detected.
OPERATION	ON	The inverter is operating properly.
	FLASHING	Grid Connected countdown

▲ Table 3.1 Status Indicator Light

3.3 Keypad (Optional)

There are four keys in the front panel of the Inverter from left to right: ESC, UP, DOWN and ENTER keys. The keypad is used for:

- Scrolling through the displayed options (the UP and DOWN keys);
- Access to modify the adjustable settings (the ESC and ENTER keys).

3.4 LCD (Optional)

The four-line Liquid Crystal Display (LCD) is located on the front panel of the Inverter, which shows the following information:

- Inverter operation status and data;
- Service messages for operator;
- Alarm messages and fault indications.

You can also get information via WiFi / GPRS.

04 Installation

4.1 Select a Location for the Inverter

To select a location for the inverter, the following criteria should be considered:

- Do not install in small closed spaces where air can not circulate freely. To avoid overheating, always make sure the flow of air around the inverter is not blocked.
- Exposure to direct sunlight will increase the operational temperature of the inverter and may cause output power limiting. Kstar recommends inverter installed to avoid direct sunlight or raining.
- To avoid overheating ambient air temperature must be considered when choosing the inverter installation location. Kstar recommends using a sun shade minimizing direct sunlight when the ambient air temperature around the unit exceeds 104°F/40°C.



▲ Figure 4.1 Recommended Installation locations

- Install on a wall or strong structure capable of bearing the weight.
- Install vertically with a maximum incline of $\pm 5^\circ$. If the mounted inverter is tilted to an angle greater than the maximum noted, heat dissipation can be inhibited, and may result in less than expected output power.
- When 1 or more inverters are installed in one location, a minimum 300mm clearance should be kept between each inverter or other object. The bottom of the inverter should be 500mm clearance to the ground.

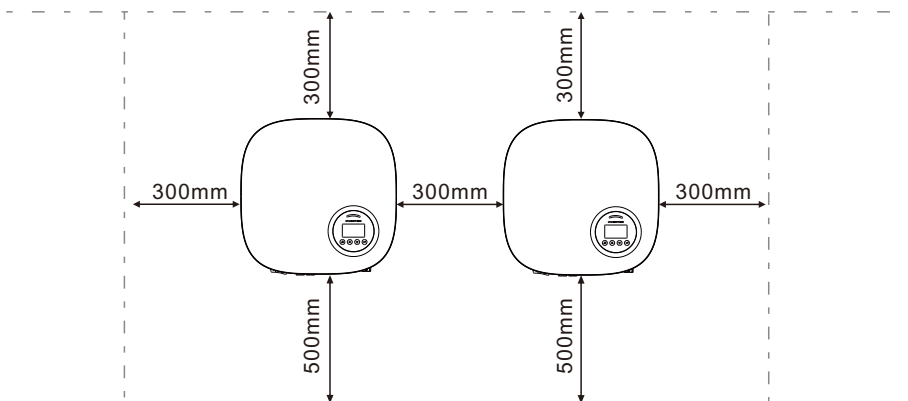

▲ Figure 4.2 Inverter Mounting clearance

- Visibility of the LED status indicator lights and the LCD located at the front panel of the inverter should be considered.
- Adequate ventilation must be provided if the inverter is to be installed in a confined space.



NOTE:

Nothing should be stored on or placed against the inverter.

4.2 Mounting the Inverter

Dimensions of wall bracket:

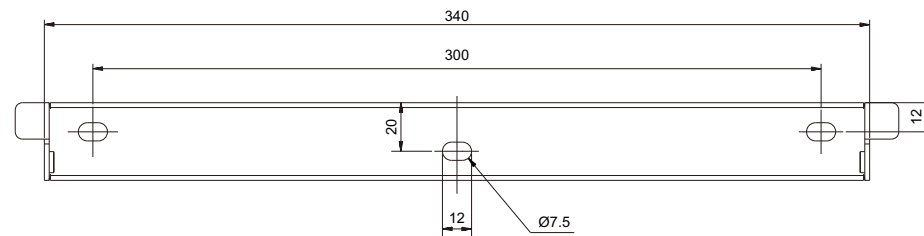

▲ Figure 4.3 Inverter wall mounting

Please see Figure 4.4 and Figure 4.5 for instruction on mounting the inverter.

The inverter shall be mounted vertically. The steps to mount the inverter are listed below:

1. According to the figure 4.2, select the mounting height of the bracket and mark the mounting holes. For brick walls, the position of the holes should be suitable for the expansion bolts.

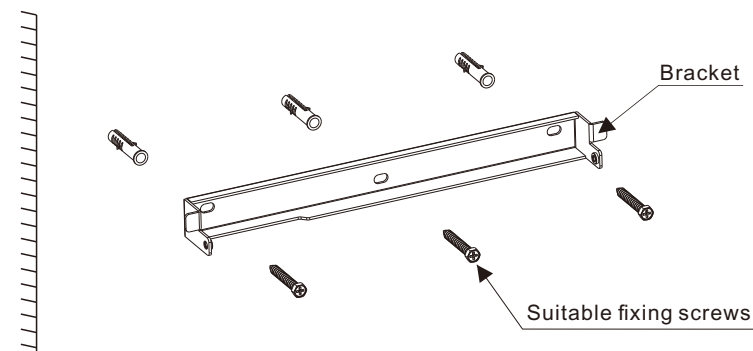

▲ Figure 4.4 Inverter wall mounting

2. Make sure the bracket is horizontal and the mounting holes (in Figure 4.4) are marked correctly. Drill the holes into the wall or pillar at your marks.
3. Use the suitable screws to fix the bracket to the wall.



WARNING:
The inverter must be mounted vertically.

4. Lift up the inverter (be careful to avoid body strain), and align the back bracket on the inverter with the convex section of the mounting bracket. Hang the inverter on the mounting bracket and make sure the inverter is secure (see Figure 4.5).

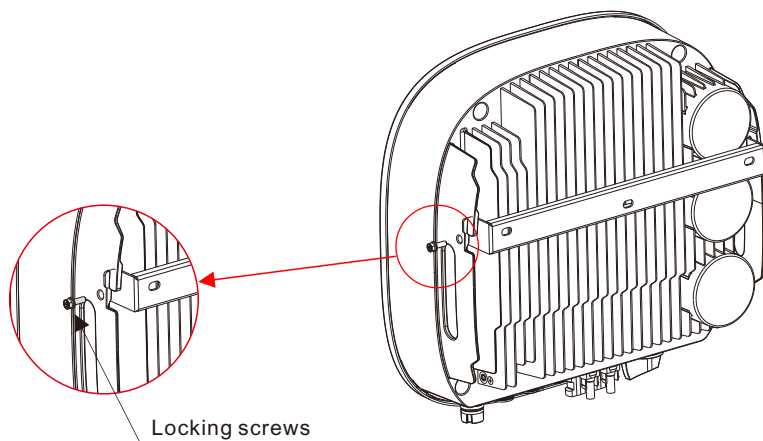

Locking screws

▲ Figure 4.5 Wall Mount Bracket

5. Use M5*16 screws in accessory to lock the inverter to the mount bracket.

4.3 Electrical Connections

4.3.1 Connect PV side of inverter

The electrical connection of the inverter must follow the steps listed below:

1. Switch the Grid Supply Main Switch (AC) OFF.
2. Switch the DC Isolator OFF.
3. Assemble PV input connector to the Inverter.



Before connecting inverter, please make sure the PV array open circuit voltage is within the limit of the inverter.

Maximum 600Voc for

3000S/3000D/3600D/4000D/4200D/4600D/5000D/6000D.



Please don't connect PV array positive or negative pole to the ground, it could cause serious damages to the inverter.



Before connection, please make sure the polarity of the output voltage of PV array matches the "DC+" and "DC-" symbols.

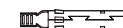
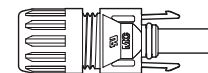

▲ Figure 4.6 DC+ Connector

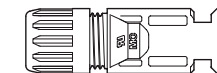

▲ Figure 4.7 DC- Connector



Please use approved DC cable for PV system.

Cable type	Cross section	
	Range	Recommended value
Industry generic PV cable(model:PV1-F)	4.0-6.0 (12-10AWG)	4.0 (12AWG)

▲ Table 4.1 DC cable

The steps to assemble the DC connectors are listed as follows:

i) Strip off the DC wire for about 7mm, Disassemble the connector cap nut.

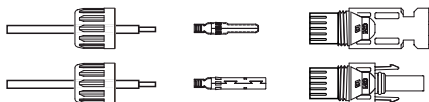

▲ Figure 4.8 Disassemble the Connector Cap nut

ii) Insert the wire into the connector cap nut and contact pin.

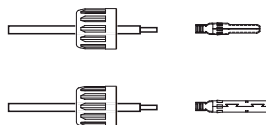

▲ Figure 4.9 Insert the Wire into the Connector Cap nut and contact pin

iii) Crimp the contact pin to the wire using a proper wire crimper.

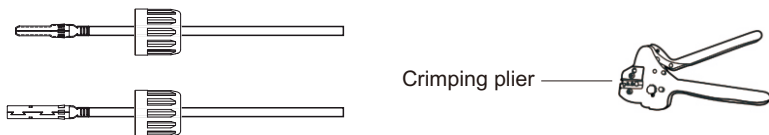

▲ Figure 4.10 Crimp the contact pin to the wire

iv) Insert the contact pin to the top part of the connector and screw up the cap nut to the top part of the connector.

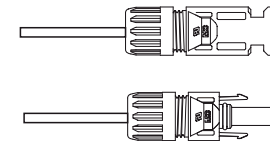

▲ Figure 4.11 Connector with Cap nut Screwed on

v) Then connect the DC connectors to the inverter. Small click will confirm connection.

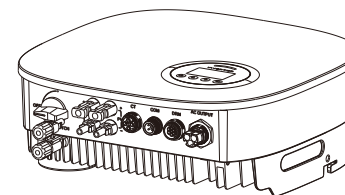

▲ Figure 4.12 Connect the DC Connectors to the Inverter

4.3.2 Connect grid side of inverter

For all AC connections, 4-10mm² 105 XJ cable is required to be used. Please make sure the resistance of cable is lower than 1 ohm. If the wire is longer than 20m, it's recommended to use 10mm² cable.



WARNING:

There are "L" "N" "⏏" symbols marked inside the connector, the Line wire of grid must be connected to "L" terminal; the Neutral wire of grid must be connected to "N" terminal; the Earth of grid must be connected to "⏏"

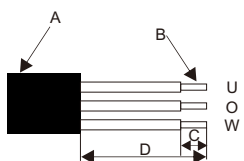

Object	Description	Value
A	External diameter	12mm to 18mm
B	Copper conductor cross-section	4mm ² to 10mm ²
C	Stripping length of the insulated conductors	approx. 13mm
D	Stripping length of the outer sheath of the AC cable	approx. 53mm

The PE conductor must be 10mm longer than the L and N conductors

b. Insert the conductor into the suitable ferrule acc. to DIN 46228-4 and crimp the contact.

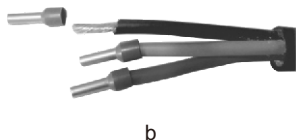

c. Unscrew the swivel nut from the threaded sleeve and thread the swivel nut and threaded sleeve over the AC cable.

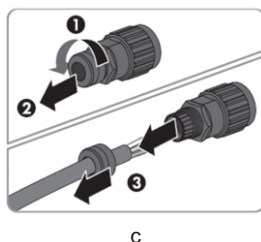

d. Insert the crimped conductors L, N and PE into the corresponding terminals and tighten the screw with a hex key wrench screwdriver(size:2.5, 1.2-2.0Nm). Ensure that all conductors are securely in place in the screw terminals on the bush insert.

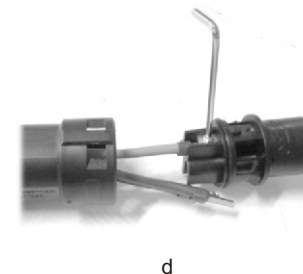

e. Screw the swivel nut onto the threaded sleeve. This seals the AC connector and provides strain relief for the AC cable. When doing so, hold the bush insert firmly by the locking cap. This ensures that the swivel nut can be screwed firmly onto the threaded sleeve.

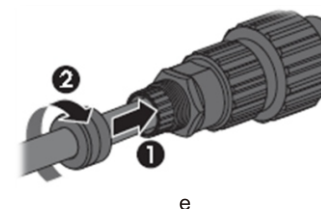

f. Assembly the plug shell ,adapter as below picture, Push the adapter and Shell by hand until a "Click" is heard or felt.

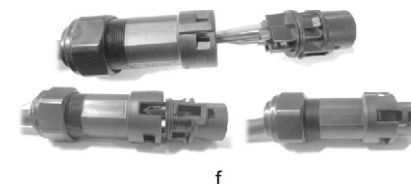

g. Plug the AC connector into the jack for the AC connection by hand until a "Click" is heard or felt.

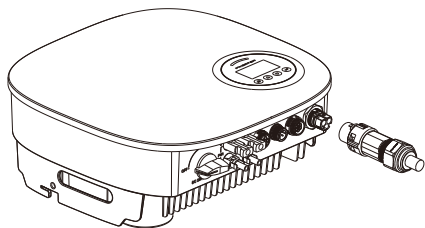

▲ Figure 4.18 Connect the AC Connector to the Inverter



Note: Connection for Split phase grid.

When connect to 208/220/240V split phase, please connect L1 to "L" terminal, L2 to "N" terminal. Also connect earth to ground terminal.

4.3.3 External ground connection

An external ground connection is provided at the right side of inverter.

Prepare OT terminals: M5. Use proper tooling to crimp the lug to the terminal.

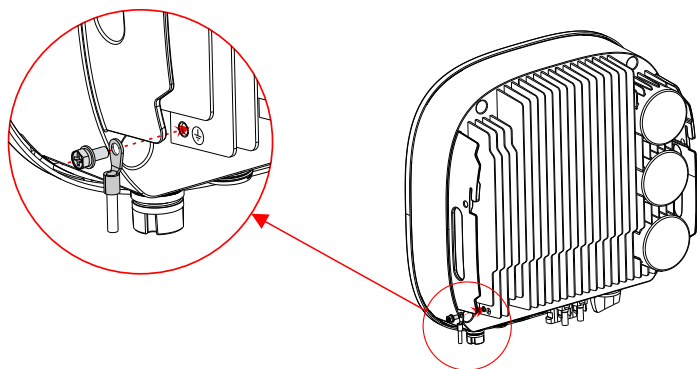

▲ Figure4.19 Connect the external grounding conductor



Note:

When earth fault occurs , the machine cannot be connected to the grid, the LED red light is on, and the LCD displays the fault code F07 until the fault is resolved.

4.3.4 Max, over current protection device (OCPD)

To protect the inverter's PV and AC grid connection conductors, Kstar recommends installing breakers that will protect against overcurrent. The following table defines OCPD ratings for the BluE-G single phase inverters.

Inverter	Rated output voltage(V)	Rated output current (A)	Current for protection device (A)
BluE-G 3000S	230	14.5	20
BluE-G 3000D	230	14.5	20
BluE-G 3600D	230	17	25
BluE-G 4000D	230	19	30
BluE-G 4200D	230	20	30
BluE-G 4600D	230	22	40
BluE-G 5000D	230	24	40
BluE-G 6000D	230	26.1	40

▲ Table 4.3 Rating of grid OCPD

Inverter	Rated input voltage(V)	Max. input current (A)	Current for protection device (A)
BluE-G 3000S	600	12.5	20
BluE-G 3000D	600	11	20
BluE-G 3600D	600	11	20
BluE-G 4000D	600	11	20
BluE-G 4200D	600	11	20
BluE-G 4600D	600	12.5	20
BluE-G 5000D	600	12.5	20
BluE-G 6000D	600	12.5	20

▲ Table 4.4 Rating of PV OCPD

4.3.5 Inverter monitoring connection

The inverter can be monitored via Wi-Fi or GPRS. All BluE-G communication devices are optional (Figure 4.20). For connection instructions, please refer to the BluE-G Monitoring Device installation manuals.

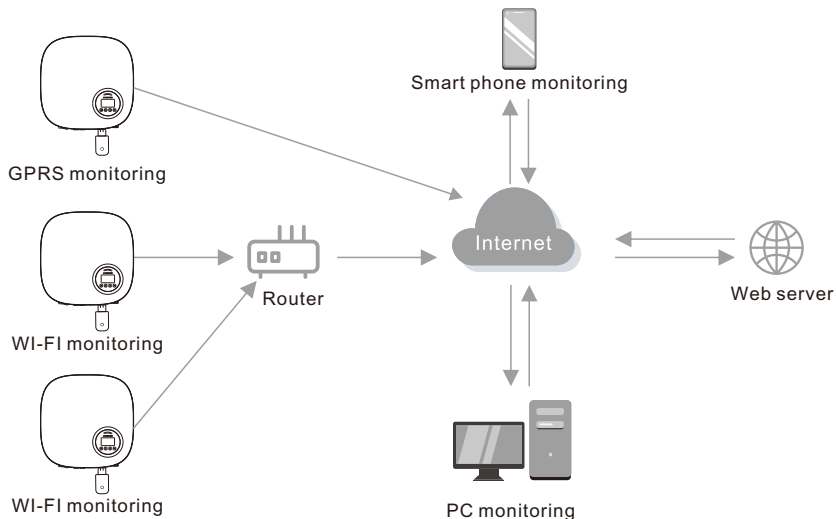

▲ Figure 4.20 Communication function

The inverter is equipped with standard RS485 and WLAN/GPRS communication ports, and the RS485 communication port is mainly used for the software upgrade, WLAN/GPRS communication port is for inverter wireless monitoring.

Pin	Description	Pin	Description
1	VCC	3	485A
2	GND	4	485B

▲ Table 4.5

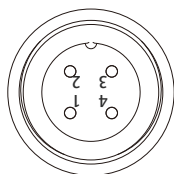

▲ Figure 4.21 Inverter WLAN/GPRS port

4.3.6 CT connections(optional)

This inverter has integrated export limitation functionality. To use this function, a CT must be installed, if use the CT, please reference below picture. The CT should be fitted around the live conductor on the grid side of the main incoming consumer unit. Use the directional flow indication arrow on the CT to ensure it is fitted in the correct orientation. The arrow should be pointing towards the grid , not the load.

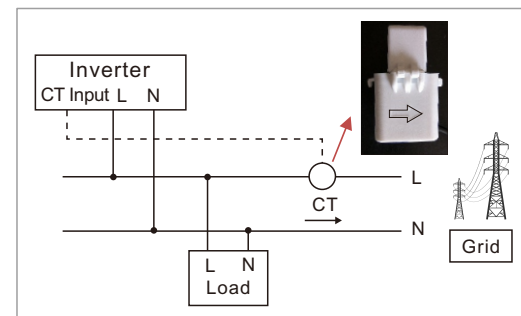

▲ Figure 4.22 Direction of CT

Pin	Description	Pin	Description
1	CT positive electrode	3	NC
2	CT negative pole	4	NC

▲ Table 4.6

Please follow below figure to assemble CT connector.

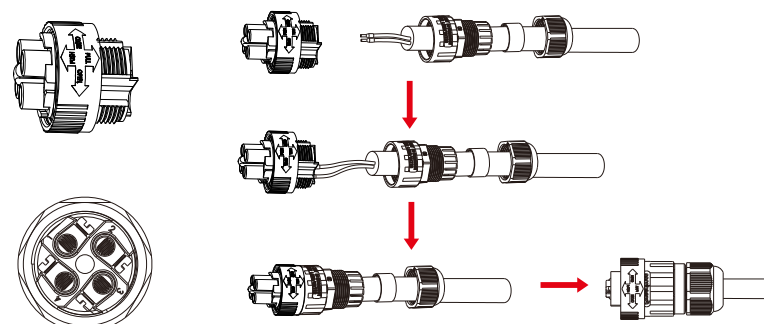

▲ Figure 4.23 CT connector

4.3.7 DRED port connections(optional)

DRED means demand response enable device. The AS/NZS 4777.2:2015 required inverter need to support demand response mode(DRM). This function is for inverter that comply with AS/NZS 4777.2:2015 standard. BluE-G single phase inverter is fully comply with all DRM. A 6P terminal is used for DRM connection.

Pin	Description	Pin	Description
1	DRM 1/5	4	DRM 4/8
2	DRM 2/6	5	RefGen
3	DRM 3/7	6	Com/DRMO

▲ Table 4.7

Please follow below figure to assemble DRM connector.

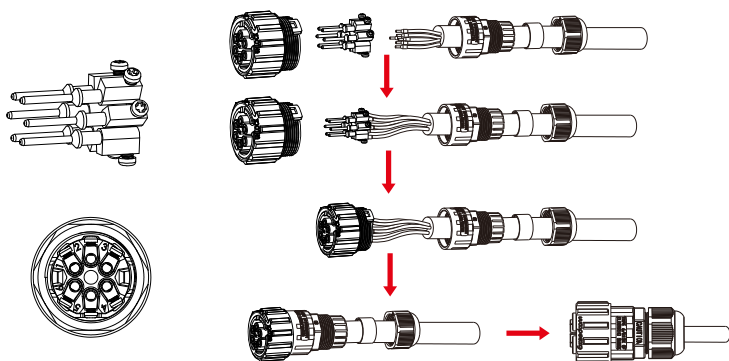

▲ Figure 4.24 DRM connector

05 Start&Stop

5.1 Start the Inverter

To start up the Inverter, it is important that the following steps are strictly followed:

1. Switch the grid supply main Switch (AC) ON first.
2. Switch the DC switch ON. If the voltage of PV arrays are higher than start up voltage, the inverter will turn on. The LED status indicator will light.
3. When both the DC and the AC sides supply to the inverter, it will be ready to generate power. Initially, the inverter will check both its internal parameters and the parameters of the AC grid, to ensure that they are within the acceptable limits. At the same time, the green LED will flash and the LCD displays the information of INITIALIZING.
4. After 20-300 seconds (depending on local requirement), the inverter will start to generate power. The green LED will be on continually and the LCD displays GENERATING.



WARNING:
Do not touch the surface when the inverter is operating. It may be hot and cause burns.

5.2 Stop the Inverter

To stop the Inverter, the following steps must be strictly followed:

1. Switch the Supply Main Switch (AC) OFF.
2. Wait 30 seconds. Switch the DC Switch OFF. All the LEDs of the inverter will be off in one minute.

06 Operation

During normal operation, the display alternately shows various status information (see Figure 6.1). Screens can also be scrolled manually by pressing the UP and DOWN keys.

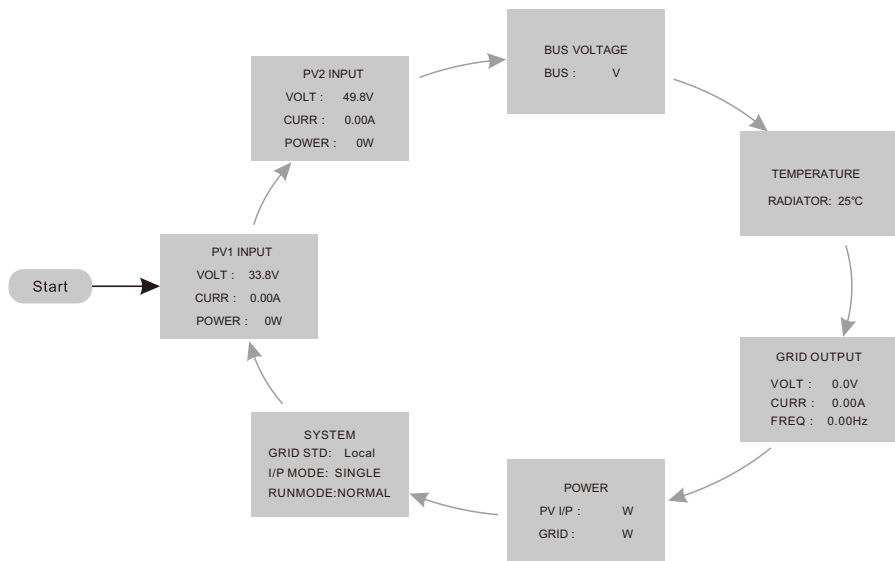

▲ Figure 6.1 Operation Overview

Lock screen

Pressing the ENTER key locks (Figure 6.2(a)) or unlocks (Figure 6.2 (b)) the screen.

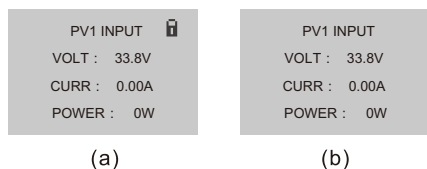

▲ Figure 6.2 Locks and Unlocks the Screen of LCD

Main Menu

Press the ESC key to access to the Main Menu , there are three submenus in the Main Menu (see Figure 6.3) :

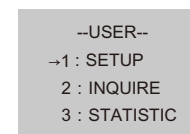

▲ Figure 6.3 Main Menu

6.1 SETUP-Technicians Only



NOTE:

To access to this area is for fully qualified and accredited technicians only. Enter menu "SETUP" need password.

Select "SETUP" from the Main Menu. The screen will require the password as below.

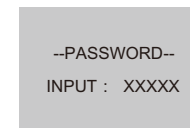

▲ Figure 6.4 Enter password

The default password is "0000". Please press "ENTER" to move the cursor backwards or confirm the setting, press "up" /"DOWN"to select the number, press "ESC" to move the cursor forward or return to the Main Menu.

After enter the correct password the Main Menu will display a screen and be able to access to the following information, You can also continue to access the next menu level. Password can be changed through item 11.

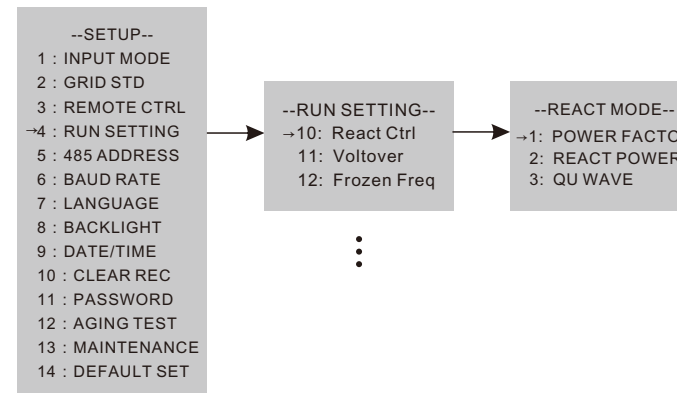



NOTE:

"POWER FACTOR" mode is selected by default, and "QU WAVE" or other modes can be selected through this page.

6.1.1 Set DATE/TIME

Please set the time and date after starting the inverter for the first time.

```
--DATE/TIME--
DATE : 2020-06-06
TIME : 10 : 01 : 12
WEEK : 6
```

▲ Figure 6.5 Set Date/Time

6.2 INQUIRE

The following submenus are displayed when the Inquiry menu is selected, You can also continue to access the next menu level.

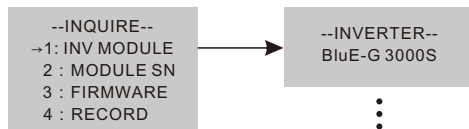

6.3 Statistics

Select Statistics from the Main Menu to access the following options, You can also continue to access the next menu level.

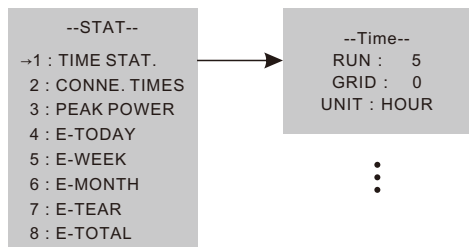

07 Maintenance

BluE Single Phase Inverter does not require any regular maintenance. However, cleaning the dust on heat-sink will help the inverter to dissipate the heat and increase its life time. The dust can be removed with a soft brush.



CAUTION:

Do not touch the inverter's surface when it is operating. Some parts of the inverter may be hot and cause burns. Turn off the inverter (refer to Section 5.2) and wait for a cool-down period before any maintenance or cleaning operation.

The LCD and the LED status indicator lights can be cleaned with a damp cloth if they are too dirty to be read.



NOTE:

Never use any solvents, abrasives or corrosive materials to clean the inverter.

08 Trouble shooting

It is very easy for the inverter's maintenance. When you meet any problems, please refer to the following trouble shooting first, please contact your local distributor if the problem can't be solved by yourself.

The following sheet lists some basic questions may encounter in the operation.

Alarm Message	Failure description	Solution
F00-F03	AC voltage & frequency are too high or too low.	<ol style="list-style-type: none"> 1. Please check mains voltage whether it is complied with local, safety standard 2. Please check the AC output line is properly connected. Make sure its output voltage to see if it is normal. 3. Disconnect PV input and restart the inverter and check whether.
F04-F05	Bus voltage is too high or too low.	<ol style="list-style-type: none"> 1. Please check the setting of input mode 2. Disconnect PV input and restart the inverter and check whether fault still exists.
F06	Bus voltage is Unbalance	<ol style="list-style-type: none"> 1. Please check the setting of input mode. 2. Disconnect PV input and restart the inverter and check whether fault still exists.
F07	Insulation impedance Fault	<ol style="list-style-type: none"> 1. Disconnect PV input and restart the inverter and check whether fault still exists. 2. Please measure impedance of PV+/PV- to ground whether is over than 500KΩ.
F08	Input Current High	<ol style="list-style-type: none"> 1. Please check the setting of input mode. 2. Disconnect PV input and restart the inverter and check whether fault still exists.
F09	Hardware Current High	<ol style="list-style-type: none"> 1. Disconnect PV input and restart the inverter after few minutes and check whether fault still exists.
F10	Inverter Current High	<ol style="list-style-type: none"> 1. Disconnect PV input and restart the inverter after few minutes and check whether fault still exists.
F11	Inverter DC Current high	<ol style="list-style-type: none"> 1. Disconnect PV input and restart the inverter after few minutes and check whether fault still exists.
F12	Amb Temperatur Over	<ol style="list-style-type: none"> 1. Disconnect PV input and cool down the inverter then restart the inverter to see if it is back to normal operation. 2. Please check environmental temperature whether out of working temperature.

Alarm Message	Failure description	Solution
F13	Heatsink Temperature High	<ol style="list-style-type: none"> 1. Disconnect PV input and cool down the inverter then restart the inverter to see if it is back to normal operation. 2. Please check environmental temperature whether out of working temperature.
F14	AC Relay Fault	<ol style="list-style-type: none"> 1. Disconnect PV input and restart the inverter and check whether fault still exists.
F15	PV Input Voltage Low	<ol style="list-style-type: none"> 1. Please check the configuration of PV input, one of PV input is idle when inverter is set on parallel mode. 2. Disconnect the PV input and restart the inverter and check whether fault still exists.
F16	Remote Off	<ol style="list-style-type: none"> 1. The inverter is on remote OFF status, the Inverter can be turned, off/on remotely by monitoring software.
F18	SPI communication Fault	<ol style="list-style-type: none"> 1. Disconnect PV input and restart the inverter and check whether fault still exists.
F20	Leakage Current High	<ol style="list-style-type: none"> 1. Disconnect PV input and restart the inverter and check whether fault still exists.
F21	Leakage Current Self-Checking Failure	<ol style="list-style-type: none"> 1. Disconnect PV input and restart the inverter and check whether fault still exists. 2. Contact with your local distributor if the fault still exists.
F22	Consistency Voltage Fault	<ol style="list-style-type: none"> 1. Disconnect PV input and restart the inverter and check whether fault still exists. 2. Contact with your local distributor if the fault still exists.
F23	Consistency Frequency Fault	<ol style="list-style-type: none"> 1. Disconnect PV input and restart the inverter and check whether fault still exists. 2. Contact with your local distributor if the fault still exists.

Alarm Message	Failure description	Solution
F24	DSP Operation Fault	1.Disconnect PV input and restart the inverter and check whether fault still exists. 2.Contact with your local distributor if the fault still exists.
F32	DSP communication Lost	1.Disconnect PV input and restart the inverter and check whether fault still exists. 2.Contact with your local distributor if the fault still exists.

▲ Table 8.1 Trouble shooting

NOTE:

If the inverter displays any alarm message as listed in Table 8.1; please turn off the inverter (refer to Section 5.2 to stop your inverter) and wait for 5 minutes before restarting it (refer to Section 5.1 to start your inverter). If the failure persists, please contact your local distributor or the service center. Please keep ready with you the following information before contacting us.

1. Serial number of BluE-G Single Phase Inverter;
2. The distributor/dealer of BluE-G Single Phase Inverter (if available);
3. Installation date.
4. The description of problem (i.e. the alarm message displayed on the LCD and the status of the LED status indicator lights. Other readings obtained from the Information submenu will also be helpful.) ;
5. The PV array configuration (e.g. number of panels, capacity of panels, number of strings ,etc.);
6. Your contact details.

09 Specifications

Model Specifications	BluE-G 3000S	BluE-G 3000D
Max. DC power	4050W	4050W
Max. DC voltage	600Vd.c.	600Vd.c.
Normal DC voltage	380Vd.c.	380Vd.c.
MPPT voltage range	80-550Vd.c.	80-550Vd.c.
Number of MPPT trackers	1	2
Strings per MPPT tracker	1	1
Max. input current per MPPT tracker	12.5Ad.c.	11Ad.c./11Ad.c.
PV short circuit current	15.6Ad.c.	13.2Ad.c./13.2Ad.c.
Normal AC output Power	3000W	3000W
Max. AC output Power	3300W	3300W
Rated Apparent Power	3300VA	3300VA
Normal AC voltage	230Va.c.	230Va.c.
Normal AC grid frequency	50/60Hz	50/60Hz
Max. output current	14.5Aa.c.	14.5Aa.c.
Inrush current	< 14.5Aa.c.	< 14.5Aa.c.
Max. output fault current	102Ad.c.	102Ad.c.
Max. inverter backfeed current to the array	0Ad.c.	0Ad.c.
Max. output overcurrent protection	62Ad.c.	62Ad.c.
Output Power Factor	~1 (Adjustable from 0.8 leading to 0.8 lagging)	
THDI	<3%	<3%
Topology	Transformer less	Transformer less
Max. efficiency	97.8%	97.8%
Euro-eta	97.5%	97.5%
Dimensions (W / L / D)	380*380*150mm	380*380*150mm
Weight(KG)	10KG	10KG
Operating temperature range	-25 °C~+60 °C(> 45°C derating)	
Relative humidity	0-100%	0-100%
Operating Altitude	≤4000m	≤4000m
Noise emission (typical)	≤ 25dB	≤ 25dB
Cooling concept	Natural	Natural
Protection rating	IP65	IP65
Protection class	I	I
Overvoltage category (PV/AC)	II/III	II/III
Pollution degree	2	2
User Interface	LED & LCD	LED & LCD
Communication	RS485/WIFI/GPRS	RS485/WIFI/GPRS

09 Specifications

Model Specifications	BluE-G 3600D	BluE-G 4000D
Max. DC power	4860W	5400W
Max. DC voltage	600Vd.c.	600Vd.c.
Normal DC voltage	380Vd.c.	380Vd.c.
MPPT voltage range	80-550Vd.c.	80-550Vd.c.
Number of MPPT trackers	2	2
Strings per MPPT tracker	1	1
Max. input current per MPPT tracker	11Ad.c. /11Ad.c.	11Ad.c. /11Ad.c.
PV short circuit current	13.2Ad.c./13.2Ad.c.	13.2Ad.c./13.2Ad.c.
Normal AC output Power	3600W	4000W
Max. AC output Power	3960W	4400W
Rated Apparent Power	3960VA	4400VA
Normal AC voltage	230Va.c.	230Va.c.
Normal AC grid frequency	50/60Hz	50/60Hz
Max. output current	17Aa.c.	19Aa.c.
Inrush current	< 17 Aa.c.	< 19 Aa.c.
Max. output fault current	102Ad.c.	102Ad.c.
Max. inverter backfeed current to the array	0Ad.c.	0Ad.c.
Max. output overcurrent protection	62Ad.c.	62Ad.c.
Output Power Factor	~1 (Adjustable from 0.8 leading to 0.8 lagging)	
THDI	<3%	<3%
Topology	Transformer less	Transformer less
Max. efficiency	97.8%	97.8%
Euro-eta	97.5%	97.5%
Dimensions (W / L / D)	380*380*150mm	380*380*150mm
Weight(KG)	10KG	11KG
Operating temperature range	-25°C~+60°C(> 45°C derating)	
Relative humidity	0-100%	0-100%
Operating Altitude	≤4000m	≤4000m
Noise emission (typical)	≤ 25dB	≤ 25dB
Cooling concept	Natural	Natural
Protection rating	IP65	IP65
Protection class	I	I
Overvoltage category (PV/AC)	II/III	II/III
Pollution degree	2	2
User Interface	LED & LCD	LED & LCD
Communication	RS485/WIFI/GPRS	RS485/WIFI/GPRS

09 Specifications

Model Specifications	BluE-G 4200D	BluE-G 4600D
Max. DC power	5670W	6210W
Max. DC voltage	600Vd.c.	600Vd.c.
Normal DC voltage	380Vd.c.	380Vd.c.
MPPT voltage range	80-550Vd.c.	80-550Vd.c.
Number of MPPT trackers	2	2
Strings per MPPT tracker	1	1
Max. input current per MPPT tracker	11Ad.c. /11Ad.c.	12.5Ad.c./12.5 Ad.c.
PV short circuit current	13.2Ad.c./13.2Ad.c.	15.6Ad.c./15.6Ad.c.
Normal AC output Power	4200W	4600W
Max. AC apparent Power	4620W	5060W
Rated Apparent Power	4620VA	5060VA
Normal AC voltage	230Va.c.	230Va.c.
Normal AC grid frequency	50/60Hz	50/60Hz
Max. output current	20Aa.c.	22Aa.c.
Inrush current	< 20Aa.c.	< 22Aa.c.
Max. output fault current	102Ad.c.	102Ad.c.
Max. inverter backfeed current to the array	0Ad.c.	0Ad.c.
Max. output overcurrent protection	62Ad.c.	62Ad.c.
Output Power Factor	~1 (Adjustable from 0.8 leading to 0.8 lagging)	
THDI	<3%	<3%
Topology	Transformer less	Transformer less
Max. efficiency	97.8%	97.8%
Euro-eta	97.5%	97.5%
Dimensions (W / L / D)	380*380*150mm	380*380*150mm
Weight(KG)	11KG	11KG
Operating temperature range	-25°C~+60°C(> 45°C derating)	
Relative humidity	0-100%	0-100%
Operating Altitude	≤4000m	≤4000m
Noise emission (typical)	≤ 25dB	≤ 25dB
Cooling concept	Natural	Natural
Protection rating	IP65	IP65
Protection class	I	I
Overvoltage category (PV/AC)	II/III	II/III
Pollution degree	2	2
User Interface	LED & LCD	LED & LCD
Communication	RS485/WIFI/GPRS	RS485/WIFI/GPRS

09 Specifications

Model Specifications	BluE-G 5000D	BluE-G 6000D
Max. DC power	6750W	8100W
Max. DC voltage	600Vd.c.	600Vd.c.
Normal DC voltage	380Vd.c.	380Vd.c.
MPPT voltage range	80-550Vd.c.	80-550Vd.c.
Number of MPPT trackers	2	2
Strings per MPPT tracker	1	1
Max. input current per MPPT tracker	12.5Ad.c./12.5Ad.c.	12.5Ad.c./12.5Ad.c.
PV short circuit current	15.6Ad.c./15.6Ad.c.	15.6Ad.c./15.6Ad.c.
Normal AC output Power	5000W	6000W
Max. AC output Power	5500W	6000W
Rated Apparent Power	5500VA	6000VA
Normal AC voltage	230Va.c.	230Va.c.
Normal AC grid frequency	50/60Hz	50/60Hz
Max. output current	24Aa.c.	26.1Aa.c.
Inrush current	<24Aa.c.	<26.1Aa.c.
Max. output fault current	102Ad.c.	102Ad.c.
Max. inverter backfeed current to the array	0Ad.c.	0Ad.c.
Max. output overcurrent protection	62Ad.c.	62Ad.c.
Output Power Factor	~1 (Adjustable from 0.8 leading to 0.8 lagging)	
THDI	<3%	<3%
Topology	Transformer less	Transformer less
Max. efficiency	97.8%	97.8%
Euro-eta	97.5%	97.5%
Dimensions (W / L / D)	380*380*150mm	380*380*150mm
Weight(KG)	11KG	11KG
Operating temperature range	-25°C~+60°C (> 45°C derating)	
Relative humidity	0-100%	0-100%
Operating Altitude	≤4000m	≤4000m
Noise emission (typical)	≤ 25dB	≤ 25dB
Cooling concept	Natural	Natural
Protection rating	IP65	IP65
Protection class	I	I
Overvoltage category (PV/AC)	II/III	II/III
Pollution degree	2	2
User Interface	LED & LCD	LED & LCD
Communication	RS485/WIFI/GPRS	RS485/WIFI/GPRS

10 Quality Assurance

When product faults occur during the warranty period, BluE-G or his partner will provide free service or replace the product with a new one.

Evidence

During the warranty period, the customer shall provide the product purchase invoice and date. In addition, the trademark on the product shall be undamaged and legible. Otherwise, BluE-G has the right to refuse to honor the quality guarantee.

Conditions

- After replacement, unqualified products shall be processed by BluE-G.
- The customer shall give BluE-G or his partner a reasonable period to repair the faulty device.

Exclusion of Liability

In the following circumstances, BluE-G has the right to refuse to honor the quality guarantee:

- The free warranty period for the whole machine/components has expired.
- The device is damaged during transport.
- The device is incorrectly installed, refitted, or used.
- The device operates in harsh environment, as described in this manual.
- The fault or damage is caused by installation, repairs, modification, or disassembly performed by a service provider or personnel not from BluE-G or his authorized partner.
- The fault or damage is caused by the use of non-standard or non-BluE-G.

components or software.

- The installation and use range are beyond stipulations of relevant international standards.
- The damage is caused by unexpected natural factors.

For faulty products in any of above cases, if the customer requests maintenance, paid maintenance service may be provided based on the judgment of BluE-G.

11 Contact Information

18 overseas branch offices



☎ PV inverter industry Pre-sales : (86)0755-89741234 Ext 8151

☎ PV inverter industry After-sales : (86)0755-89741234 Ext 8729

✉ Global overseas service mailbox : overseas_service@kstar.com.cn